



SOLS TECHNIQUE BASED ENCODER FOR DEDICATED SHORT RANGE COMMUNICATION IN INTELLIGENT TRANSPORTATION SYSTEM APPLICATIONS

C Devi Supraja

Department of Electronics and Communication Engineering,
Institute of Aeronautical Engineering, Hyderabad, India

R Gangadhar Reddy

Department of Electronics and Communication Engineering,
Institute of Aeronautical Engineering, Hyderabad, India

T. Kalyani

Department of Electronics and Communication Engineering,
MLR Institute of Technology, Hyderabad, India

M. Ramesh Babu

Department of Electronics and Communication Engineering,
Institute of Aeronautical Engineering, Hyderabad, India

ABSTRACT

A protocol which is mainly used for intelligent transportation system is the dedicated short range communication (DSRC). By this protocol the information signals which are transmitted are encoded by using either FM0 or Manchester codes. The designing of VLSI architecture is limited by the code diversity between these two codes that supports the both. Hence this paper gives a new VLSI architecture design which can be fully reused by using both the codes. This proposed design is based on similarity oriented logic simplification (SOLS) technique which achieves an efficient performance compared with sophisticated works.

Key words: SOLS, DSRC, VLSI, Transportation System.

Cite this Article: C Devi Supraja, R Gangadhar Reddy, T. Kalyani, M. Ramesh Babu, SOLS Technique Based Encoder for Dedicated Short Range Communication in Intelligent Transportation System Applications. *International Journal of Civil Engineering and Technology*, 8(8), 2017, pp. 1197–1202

<http://www.iaeme.com/IJCIET/issues.asp?JType=IJCIET&VType=8&IType=8>

1. INTRODUCTION

Dedicated Short Range Communication (DSRC) is a protocol which is used for a short distance range of communication through a dedicated channel. This DSRC introduces intelligent transport system into our day to day life. The DSRC communication supports in both vehicle to vehicle communication and vehicle to roadside communication. The vehicle to vehicle communication mainly consider with the collision alarms, hard break warnings etc.

The vehicle to infrastructure communication comprises the Electronic Toll Collection (ETC), highway-rail intersection warning, in vehicle signing etc. However, for the DSRC communication channel the primary motivation is collision detection and vehicular safety. In addition to it, it also support in smooth traffic control. The DSRC equipment mainly contains three modules. They are base band processors, RF front end and the microprocessors. The microprocessors are responsible for scheduling the tasks of base band processing, RF front end and intercept the instructions. The RF front end is responsible for the transmission and reception of data. Finally, the main function of the base band processing contains modulation, error correction, clock synchronization, and encoding. An FM0 or Manchester encoding are used for encoding data. Hence these reduce the chances of occurrence of noise in the channel when it is left idle. The system which can be reused between both the FM0 and Manchester encodings can reduce the hardware utilization rate and then reducing the efficiency. This also affects the performance of the system. Hence a new method of designing a reusable VLSI architecture is proposed. The modern method of designing called the Similarity Oriented Logic Simplification (SOLS) is proposed. It improves the hardware utilization rate of the reusable architecture and then improves the performance and area footage.

2. RELATED TECHNOLOGIES

2.1. DSRC Protocol

Dedicated short range communication (DSRC) is a quick, short to mid range wireless technology. DSRC is used to enables one way or two way communication between vehicles or between vehicles and roadside. It is used for making streets safer, traveling easier and minimizes the impact on the vehicles. It gives the ability for vehicles and infrastructure to communicate with each other at a rate of 10 times per second. The most important concern is collision detection in DSRC communication. Each DSRC facilitate vehicle broadcasts its basic information including speed, trajectory, location etc to a short range of distance i.e, a few hundred meters. All other DSRC equipped vehicles in that domain receives this message. After that receiver vehicles can decoded on this message and a caution or warning may be given to the driver. This can be issued audibly, visually or haptically. The DSRC communication is a direct communication between vehicles and it does not require any networking. Therefore it is also referred to as single hop. This type of communication can also be introduced as uncoordinated broadcast messaging. This network is extended by the each DSRC equipped vehicles to its neighbors and hence it can grow unbounded. It is also an important concern for safety, privacy. Hence, all safety communications are performed in the control channel only. Two types of messages are involved in the safety communication:

- Routine safety messages: These are status messages that are regularly sent by the vehicle which includes change of speed, location, etc
- Event safety messages: These are messages that indicate an event like a hard brake.

3. METHODOLOGY

3.1. FM0 Encoding

The encoding which is a type of Non-Return to Zero code is FM0 encoding. This encoding is also used to represent the binary signals in a digital system. In FM0 encoding, the encoded signal experiences a transition for every clock cycle even though the data stream does not encounter transition. The FM0 encoding can be specified by using the three basic rules. They are as follows:

1. For every logic zero input there should be transition within a clock cycle.
2. For logic one input there should be no transition.
3. After every clock cycle irrespective of the input data there should be a transition.

By using two flip-flops and also multiplexers the FM0 encoding can be realized. As shown in the below block diagram of fig1 the FM0 encoding can be implemented. In the below block diagram, A(t) and B(t) indicate the two states.

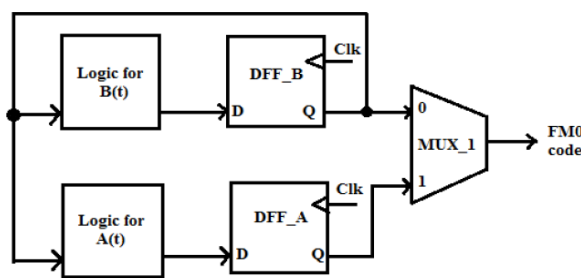

Figure 1 FM0 Encoding

3.2. Manchester Encoding

Now-a-days one of the most common data coding methods used is Manchester encoding. Manchester coding provides a way of adding the data rate clock to the message to be used at the receiving end. The Manchester codes are used to represent the binary values 1 and 0 in digital system. In Manchester coding, there will always be a transition of the message signal at the mid-point of the data bit frame. On the state of the previous bit frame the bit edge are depended and does not always provide a transition. A logical 1 is determined as a mid-point transition from low to high and a 0 is a mid-point transition from high to low. Fig 2 shows an example for a Manchester encoding.

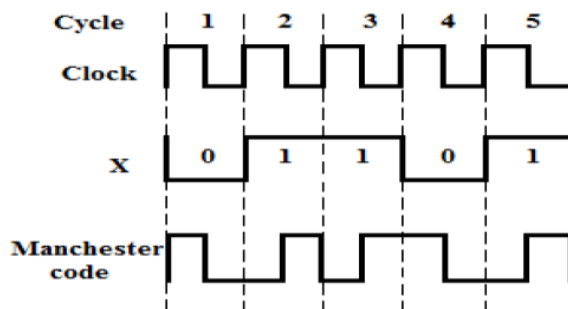

Figure 2 Manchester Encoding

By using an XOR gate the Manchester encoding can be implemented and to obtain the encoded data the clock signal and the data signal are XORed together as shown in the diagram below Fig 3.

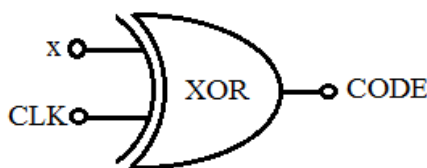

Figure 3 Encoded Data with XOR

3.3. SOLS Technique

DSRC encoders are makes use of both the FM0 and the Manchester encoding. Hence to form a reusable encoder both the encoders can be combined together. Such a reusable encoder can be explained as shown in the figure 4.

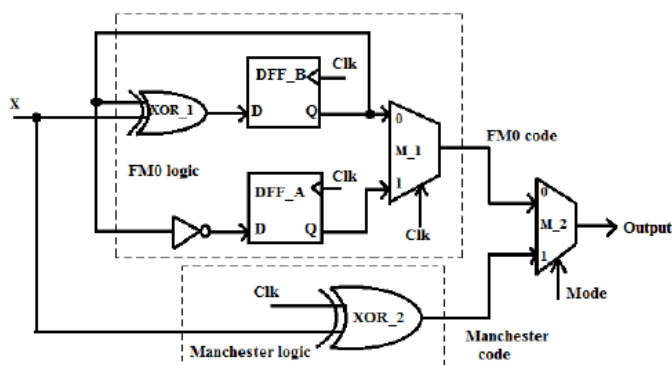

Figure 4 SOLS Technique

Moreover, this block diagram can be simplified by using the SOLS technique. Two methods are considered for the SOLS technique, area compact retiming and the balance logic simplification.

3.3.1. Area Compact Retiming

Mainly, to simplifying the FM0 encoder this method is used. The state code of each state A(t) and B(t) is stored into separate flip flops for FM0 encoder. Since the state code transition is only depends on B(t), the encoder only needs a single bit flip flop. Hence the block diagram is rearranged as shown in the fig 5.

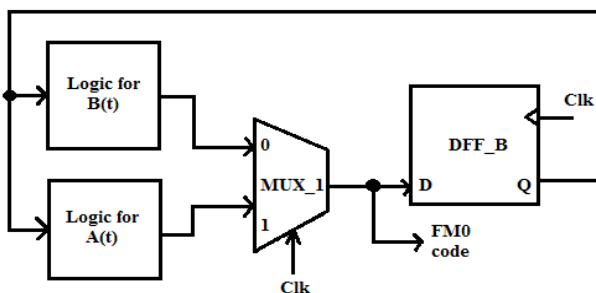

Figure 5 FM0 Encoder with States

3.3.2. Balance Logic Simplification

The Manchester encoder deals with this technique. The Manchester encoding can be considered as the XORing between the input signal and the clock. It can also be treated as a Multiplexer where the clock is given as the select input and the data and its complement is given as the data input. This is explained by the below fig 6.

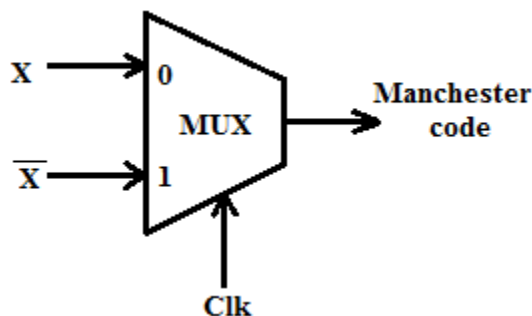

Figure 6 Manchester Encoder with Balance Logic

4. RESULTS AND DISCUSSION

4.1. RTL Schematic

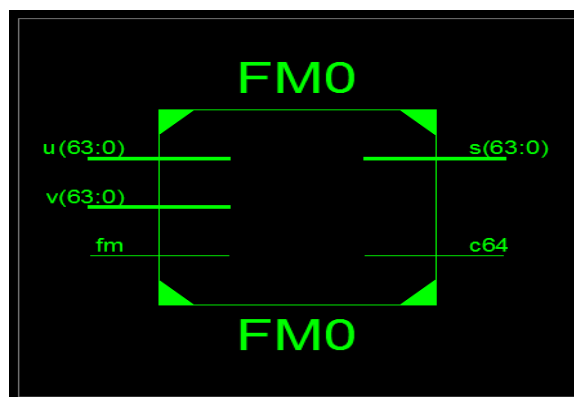

Figure 7 RTL Schematic

4.2. Output Waveform

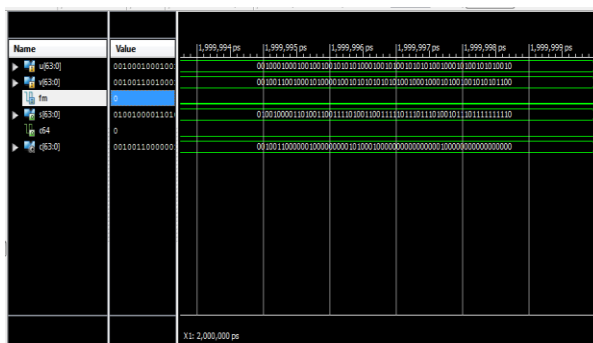

Figure 8 Output Waveform

5. CONCLUSIONS

The smart transport system has its own advantages like smooth traffic control, vehicular safety etc. DSRC communication protocol is used for implementing such a system. In DSRC communication, the safety messages are encoded and transmitted to the other DSRC equipped vehicles which in turn enhances the security of the vehicles. By using FM0 and Manchester encoding the data is encoded. For such a reusable encoder the wide code diversity limits the hardware utilization rate. Hence a modern method of designing such an encoder called SOLS technique can be used. The SOLS encoder is of better advantage than the normal reusable encoder in terms of device utilization. Besides the logic delay and memory usage of the system also get reduced.

REFERENCES

- [1] Yu-Hsuan Lee, Cheng-Wei Pan, "Fully Reused VLSI Architecture of FM0/Manchester Encoding Using SOLS Technique for DSRC Applications", IEEE trans. Very Large Scale Integr. (VLSI) Syst., vol. pp, issue 99, Feb 2014
- [2] Sarika. G. Joshi, Vaishali S Dhongde., HDLC Protocol Implementation Using VHDL, IJRSET., vol. 3. Special issue 4, April 2014.
- [3] F. Ahmed-Zaid, F. Bai, S. Bai, C. Basnayake, B. Bellur, S. Brovold, et al., Vehicle safety communications Applications (VSC-A) final report, U.S. Dept. Trans., Nat. Highway Traffic Safety Admin., Washington, DC, USA, Rep. DOT HS 810 591, Sep. 2011.
- [4] J. B. Kenney, Dedicated short-range communications (DSRC) standards in the United States, Proc. IEEE, vol. 99, no. 7, pp. 11621182, Jul. 2011.
- [5] A. Karagounis, A. Polyzos, B. Kotsos, and N. Assimakis, A 90nm Manchester code generator with CMOS switches running at 2.4 GHz and 5 GHz, in Proc. 16th Int. Conf. Syst., Signals Image Process., Jun. 2009, pp. 14.
- [6] Y.-C. Hung, M.-M. Kuo, C.-K. Tung, and S.-H. Shieh, High-speed CMOS chip design for Manchester and Miller encoder, in Proc. Intell. Inf. Hiding Multimedia Signal Process., Sep. 2009, pp. 538541.
- [7] M. A. Khan, M. Sharma, and P. R. Brahmanandha, FSM based FM0 and Miller encoder for UHF RFID tag emulator, in Proc. IEEE Adv. Comput. Conf., Mar. 2009, pp. 13171322.
- [8] M. A. Khan, M. Sharma, and P. R. Brahmanandha, FSM based Manchester encoder for UHF RFID tag emulator, in Proc. Int. Conf. Comput., Commun. Netw., Dec. 2008, pp. 16.
- [9] J. Daniel, V. Taliwal, A. Meier, W. Holfelder, and R. Herrtwich, Design of 5.9 GHz DSRC-based vehicular safety communication, IEEE Wireless Commun. Mag., vol. 13, no. 5, pp. 3643, Oct. 2006.
- [10] Dr.S.Ramachandran and S.Aravindan An Analysis of Traffic, Transportation And Operations of Nargolport, India –A Case Study. International Journal of Civil Engineering and Technology, 8(6), 2017, pp. 465–476.
- [11] Debalina Banerjee, P. Jagadeesh and Ramamohan Rao .P, Risk Analysis and Decision Support in Transportation Megaprojects, International Journal of Civil Engineering and Technology, 8(7), 2017, pp. 8 36–845.